

# Amersham™ Eraser

## Operating Instructions

Original instructions

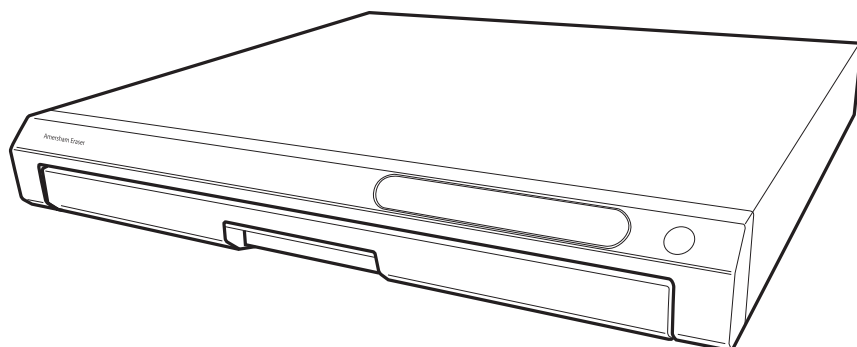

# Table of Contents

<b>1</b>	<b>Introduction</b> .....	<b>3</b>
1.1	Important user information .....	3
1.2	Regulatory information .....	5
<b>2</b>	<b>Safety instructions</b> .....	<b>8</b>
2.1	Safety precautions .....	8
2.2	Labels .....	12
2.3	Emergency procedure .....	15
2.4	Recycling .....	15
2.5	Declaration of Hazardous Substances (DoHS) .....	17
<b>3</b>	<b>Product description</b> .....	<b>19</b>
<b>4</b>	<b>Installation</b> .....	<b>23</b>
4.1	Site requirements .....	23
4.2	Transport .....	24
4.3	Unpacking .....	24
4.4	Connections .....	24
4.5	Placement .....	25
<b>5</b>	<b>Operation</b> .....	<b>26</b>
5.1	Erase a storage phosphor screen .....	28
5.2	Erasure time guidelines .....	32
<b>6</b>	<b>Maintenance</b> .....	<b>33</b>
<b>7</b>	<b>Troubleshooting</b> .....	<b>34</b>
<b>8</b>	<b>Reference information</b> .....	<b>35</b>
	<b>Index</b> .....	<b>37</b>

# 1 Introduction

## Purpose of this manual

The *Operating Instructions* provide you with the information needed to install, operate, and maintain the Amersham Eraser in a safe way.

---

## About this chapter

This chapter contains important user information, and a general description of the Amersham Eraser and its intended use.

---

## 1.1 Important user information

### Read this before operating the product



**All users must read the entire *Amersham Eraser Operating Instructions* before installing, operating or maintaining Amersham Eraser.**

Always keep the *Amersham Eraser Operating Instructions* at hand when operating the Amersham Eraser.

Do not operate the product in any other way than described in the user documentation. If you do, you may be exposed to hazards that can lead to personal injury and you may cause damage to the equipment.

---

### Intended use

The Amersham Eraser is used for erasing storage phosphor screens.

The Amersham Eraser is intended for research use only, and shall not be used in any clinical procedures or for diagnostic purposes.

---

## 1 Introduction

### 1.1 Important user information

## Prerequisites

In order to operate the Amersham Eraser in the way it is intended, the following prerequisites must be fulfilled:

- You should read and understand the safety instructions outlined in this manual.
  - The instrument should be installed according to the instructions in this manual.
- 

## Safety notices

This user documentation contains safety notices (WARNING, CAUTION, and NOTICE) concerning the safe use of the product. See definitions below.



### WARNING

**WARNING** indicates a hazardous situation which, if not avoided, could result in death or serious injury. It is important not to proceed until all stated conditions are met and clearly understood.



### CAUTION

**CAUTION** indicates a hazardous situation which, if not avoided, could result in minor or moderate injury. It is important not to proceed until all stated conditions are met and clearly understood.



### NOTICE

**NOTICE** indicates instructions that must be followed to avoid damage to the product or other equipment.

## Notes and tips

**Note:** *A note is used to indicate information that is important for trouble-free and optimal use of the product.*

**Tip:** *A tip contains useful information that can improve or optimize your procedures.*

---

## 1.2 Regulatory information

### Introduction

This section lists the directives and standards that are fulfilled by the Amersham Eraser.

---

### Manufacturing information

The table below summarizes the required manufacturing information.

Requirement	Information
Name and address of manufacturer	GE Healthcare Bio-Sciences AB, Björkgatan 30, SE 751 84 Uppsala, Sweden

### Conformity with EU Directives

This product complies with the European directives listed in the table, by fulfilling the corresponding harmonized standards.

A copy of the EU Declaration of Conformity is available on request.

Directive	Title
2006/42/EC	Machinery Directive (MD)
2014/30/EU	Electromagnetic Compatibility (EMC) Directive
2014/35/EU	Low Voltage Directive (LVD)

## CE marking



The CE marking and the corresponding EU Declaration of Conformity is valid for the instrument when it is:

- used as a stand-alone unit, or
  - connected to other products recommended or described in the user documentation, and
  - used in the same state as it was delivered from GE, except for alterations described in the user documentation.
- 

## International standards

Harmonized standard requirements fulfilled by this product are summarized in the table below.

Standard	Description	Notes
EN 61010-1, IEC 61010-1, UL 61010-1, CAN/CSA-C22.2 No. 61010-1	Safety requirements for electrical equipment for measurement, control, and laboratory use.	EN standard is harmonized with EU directive 2014/35/EU
EN 61326-1, IEC 61326-1, FCC Part 15 B Class A, ICES-003 Class A	Electrical equipment for measurement, control and laboratory use - EMC requirements.	EN standard is harmonized with 2014/30/EU
EN ISO 12100	Safety of machinery. General principles for design. Risk assessment and risk reduction.	Harmonized with 2006/42/EC
EN60529	Degrees of protection provided by enclosures.	EN standard is harmonized with EU directive 2014/35/EU

## FCC compliance

This device complies with part 15 of the FCC Rules. Operation is subject to the following two conditions: (1) This device may not cause harmful interference, and (2) this device must accept any interference received, including interference that may cause undesired operation.

**Note:** *The user is cautioned that any changes or modifications not expressly approved by GE could void the user's authority to operate the equipment.*

This equipment has been tested and found to comply with the limits for a Class A digital device, pursuant to part 15 of the FCC Rules. These limits are designed to provide reasonable protection against harmful interference when the equipment is operated in a commercial environment. This equipment generates, uses, and can radiate radio frequency energy and, if not installed and used in accordance with the instruction manual, may cause harmful interference to radio communications. Operation of this equipment in a residential area is likely to cause harmful interference in which case the user will be required to correct the interference at his own expense.

---

## Environmental conformity

This product conforms to the following environmental requirements.

Requirement	Title
2011/65/EU	Restriction of Hazardous Substances (ROHS) Directive
2012/19/EU	Waste Electrical and Electronic Equipment (WEEE) Directive
ACPEIP	Administration on the Control of Pollution Caused by Electronic Information Products, China Restriction of Hazardous Substances (RoHS)
Regulation (EC) No 1907/2006	Registration, Evaluation, Authorization and restriction of Chemicals (REACH)

## 2 Safety instructions

### About this chapter

This chapter describes safety precautions, labels and symbols that are attached to the instrument. In addition, the chapter describes emergency and recovery procedures, and provides recycling information.

---

### Important



#### **WARNING**

**Before installing, operating or maintaining the product, all users must read and understand the entire contents of this chapter to become aware of the hazards involved.**

### Introduction

The Amersham Eraser is powered by mains voltage. Before installing, operating or maintaining this equipment, you must be aware of the hazards described in this manual. Follow the instructions provided to avoid personal injury or damage to the equipment.

---

## 2.1 Safety precautions

### General precautions



#### **WARNING**

Do not operate the Amersham Eraser in any other way than described in the Amersham Eraser Operating Instructions.





**WARNING**

Do not use Amersham Eraser if it is not working properly, or if it has suffered any damage, for example:

- damage to the power cord or its plug
- damage caused by dropping the equipment
- damage caused by splashing liquid onto it



**WARNING**

Do not modify this instrument. Unauthorized modification can cause fire or electric shock.

## Installation and maintenance



**WARNING**

**Power cord.** Only use power cords with approved plugs delivered or approved by GE.



**WARNING**

**Access to power switch and power cord with plug.** Do not block access to the power switch and power cord. The power switch must always be easy to access. The power cord with plug must always be easy to disconnect.



**WARNING**

**Disconnect power.** Always disconnect power from the instrument before performing any maintenance task.



**WARNING**

Disconnect the power cord before cleaning the instrument.

## 2 Safety instructions

### 2.1 Safety precautions



#### **WARNING**

Use only a slightly damp cloth to clean the instrument. Excess dampness may cause fire or electric shock. Never use a damp cloth to clean the inside of the Amersham Eraser.



#### **WARNING**

Do not place any vessels containing water or metallic objects on the instrument. If liquid or metallic objects penetrate the instrument, fire and electric shock may result.



#### **CAUTION**

Make sure that the instrument has reached room temperature before starting the power supply, if previously placed in a cold room.



#### **CAUTION**

The AC outlet requires grounding. It is necessary to connect the AC cable of Amersham Eraser with a 2P + E type AC outlet to avoid personal injury, external noises and to ensure stable operation of the equipment. The AC outlet requires grounding according to the electrical facility engineering standards.



#### **CAUTION**

Install the Amersham Eraser in a location where it will not come into contact with water or chemicals.



#### **CAUTION**

When moving the instrument do not hold the tray, it may open and cause injury.

## System operation



### WARNING

If liquid is spilled on the instrument, the electrical power supply must be disconnected immediately. The instrument must be completely dry on the inside and the outside before reconnecting the power supply.



### WARNING

If a metallic object, water, fluid or foreign matter penetrates the instrument, turn off the instrument, disconnect the AC power cable, and contact the GE representative. Failure to disconnect the power under these circumstances may cause fire or electric shock.



### WARNING

Do not use the instrument if smoke, strange noises or strange odors can be perceived, or if the instrument becomes unusually hot. This can result in fire or electric shock. Stop using the equipment immediately, turn off the power switch and unplug the equipment from the power outlet. Contact your GE representative to request repair.



### CAUTION

Do not place heavy objects on the instrument, these may fall off and cause injury.



### CAUTION

When opening or closing the tray, make sure that no objects or body parts are caught in the tray when closing.



### CAUTION

Do not press your hand or place heavy objects on the instrument. The surface may break and cause personal injury.

## 2 Safety instructions

### 2.1 Safety precautions



#### CAUTION

When lifting and moving the instrument be careful not to drop it. This may cause injury.



#### CAUTION

Do not look directly at an Amersham Eraser light source, it may cause injury to the eyes.



#### CAUTION

Do not lean on the tray, it might cause breakage to the instrument, or the instrument may tip over and cause injury.



#### CAUTION

Do not insert hands into the Amersham Eraser while the tray is open.

## 2.2 Labels

### Labels on the rear side

On the rear side of the Amersham Eraser are two labels attached describing the equipment specifications as well as precautions necessary to safely use the Amersham Eraser.

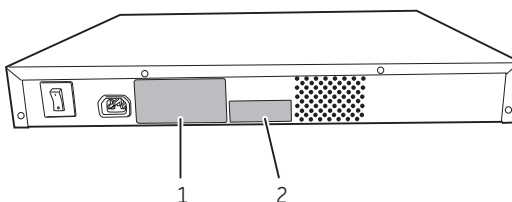



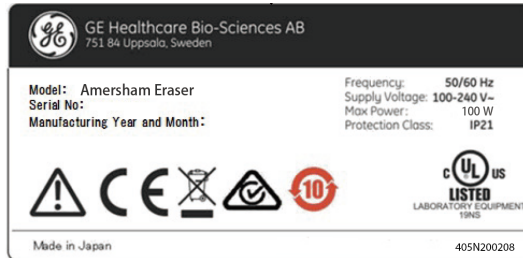

Part	Function
1	System label
2	FCC and ICES label

## System label



The illustration below shows an example of a system label.



Label text	Description
Model	Instrument model
Serial number	Instrument serial number
Manufacturing Year and Month	Manufacturing year and month
Frequency	Supply voltage frequency
Supply Voltage	Supply voltage
Max power	Max. power consumption
Protection class	Protection class. Ingress protection according to IEC 60529.
	<b>Warning!</b> Read the user documentation before using the system. Do not open any covers or replace parts unless specifically stated in the user documentation.
	The system complies with applicable European directives.
	This symbol indicates that waste electrical and electronic equipment must not be disposed as unsorted municipal waste and must be collected separately. Please contact an authorized representative of the manufacturer for information concerning the decommissioning of equipment.
	The system complies with the requirements for electromagnetic compliance (EMC) in Australia and New Zealand.

## 2 Safety instructions

### 2.2 Labels

Label text	Description
	This symbol indicates that the product contains hazardous materials in excess of the limits established by the Chinese standard <i>SJ/T11363-2006 Requirements for Concentration Limits for Certain Hazardous Substances in Electronics</i> .
	The instrument complies with a UL standard.

### FCC and ICES label

The illustration below shows an example of the FCC and ICES label placed on the rear side of the instrument.

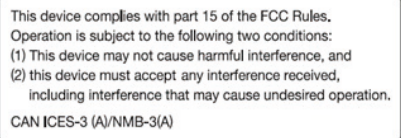
Label	Text on the label
	<p>This device complies with part 15 of the FCC rules. Operation is subject to the following conditions:</p> <ol style="list-style-type: none"><li>1 This device may not cause harmful interference, and</li><li>2 this device must accept any interference received, including interference that may cause undesired operation.</li></ol> <p>CAN ICES-3(A)/NMB-3(A) indicates that this product complies with the Canadian standard ICES-003 concerning technical requirements relative to radio noise generated by Information Technology Equipment.</p>

## 2.3 Emergency procedure

### Precautions



#### WARNING

**Access to power switch and power cord with plug.** Do not block access to the power switch and power cord. The power switch must always be easy to access. The power cord with plug must always be easy to disconnect.

### Emergency shutdown

Follow the instructions below in an emergency situation:

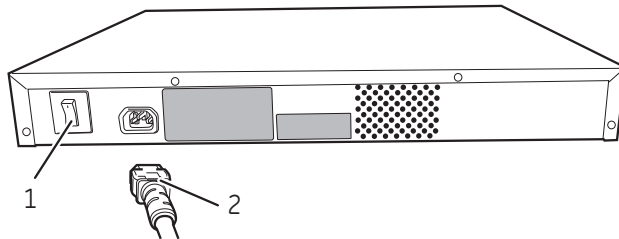

Step	Action
1	Turn off the power switch.
2	Disconnect the power cable from the power outlet.

## 2.4 Recycling

### Decontamination

The product must be decontaminated before decommissioning. All local regulations must be followed with regard to scrapping of the equipment.

## 2 Safety instructions

### 2.4 Recycling

#### Disposal of the product

When taking the product out of service, the different materials must be separated and recycled according to national and local environmental regulations.

---

#### Disposal of electrical components



Waste electrical and electronic equipment must not be disposed as unsorted municipal waste and must be collected separately. Please contact an authorized representative of the manufacturer for information concerning the decommissioning of the equipment.

---



## 2.5 Declaration of Hazardous Substances (DoHS)

根据SJ/T11364-2014《电子电气产品有害物质限制使用标识要求》特提供如下有关污染控制方面的信息。

The following product pollution control information is provided according to SJ/T11364-2014 Marking for Restriction of Hazardous Substances caused by electrical and electronic products.

### 电子信息产品污染控制标志说明 Explanation of Pollution Control Label



该标志表明本产品含有超过中国标准GB/T 26572《电子电气产品中限用物质的限量要求》中限量的有害物质。标志中的数字为本产品的环保使用期，表明本产品在正常使用的条件下，有毒有害物质不会发生外泄或突变，用户使用本产品不会对环境造成严重污染或对其人身、财产造成严重损害的期限。单位为年。

为保证所声明的环保使用期限，应按产品手册中所规定的环境条件和方法进行正常使用，并严格遵守产品维修手册中规定的定期维修和保养要求。

产品中的消耗件和某些零部件可能有其单独的环保使用期限标志，并且其环保使用期限有可能比整个产品本身的环保使用期限短。应到期按产品维修程序更换那些消耗件和零部件，以保证所声明的整个产品的环保使用期限。

本产品在使用寿命结束时不可作为普通生活垃圾处理，应被单独收集妥善处理。

This symbol indicates the product contains hazardous materials in excess of the limits established by the Chinese standard GB/T 26572 Requirements of concentration limits for certain restricted substances in electrical and electronic products. The number in the symbol is the Environment-friendly Use Period (EFUP), which indicates the period during which the hazardous substances contained in electrical and electronic products will not leak or mutate under normal operating conditions so that the use of such electrical and electronic products will not result in any severe environmental pollution, any bodily injury or damage to any assets. The unit of the period is "Year".

In order to maintain the declared EFUP, the product shall be operated normally according to the instructions and environmental conditions as defined in the product manual, and periodic maintenance schedules specified in Product Maintenance Procedures shall be followed strictly.

Consumables or certain parts may have their own label with an EFUP value less than the product. Periodic replacement of those consumables or parts to maintain the declared EFUP shall be done in accordance with the Product Maintenance Procedures.

This product must not be disposed of as unsorted municipal waste, and must be collected separately and handled properly after decommissioning.

## 2 Safety instructions

### 2.5 Declaration of Hazardous Substances (DoHS)

该标志表明本产品不含有超过中国标准GB/T 26572《电子信息产品中有毒有害物质的限量要求》中限量的有毒有害物质,报废后可以回收处理,不能随意丢弃。

This symbol indicates that this electrical and electronic product does not contain any hazardous substances above the maximum concentration value established by the Chinese standard GB/T 26572, and can be recycled after being discarded, and should not be casually discarded.

#### 有害物质的名称及含量

#### Name and Concentration of Hazardous Substances

##### 产品中有害物质的名称及含量

Table of Hazardous Substances' Name and Concentration

部件名称 Component name	有毒有害物质或元素 Hazardous substance					
	铅 (Pb)	汞 (Hg)	镉 (Cd)	六价铬 (Cr6+)	多溴联苯 (PBB)	多溴二苯醚 (PBDE)
29187190	X	0	0	0	0	0

0: 表示该有害物质在该部件所有均质材料中的含量均在GB/T 26572规定的限量要求以下。

X: 表示该有害物质至少在该部件的某一均质材料中的含量超出GB/T 26572规定的限量要求。

- 此表所列数据为发布时所能获得的最佳信息。

0: Indicates that this hazardous substance contained in all of the homogeneous materials for this part is below the limit requirement in GB/T 26572.

X: Indicates that this hazardous substance contained in at least one of the homogeneous materials used for this part is above the limit requirement in GB/T 26572.

- Data listed in the table represents best information available at the time of publication.

# 3 Product description

## About this chapter

This chapter contains important user information, and a general description of the Amersham Eraser and its intended use.

---

## Amersham Eraser front view

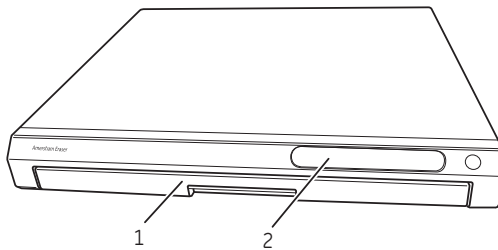

Part	Function
1	Tray
2	Panel with LED indicators

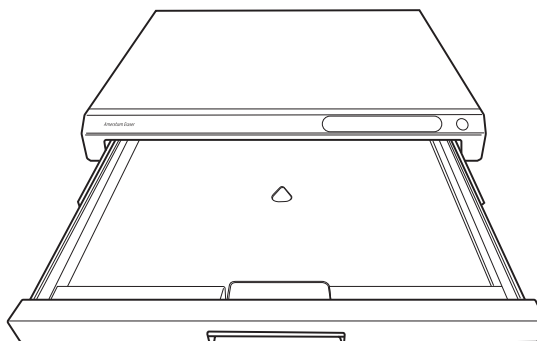

## Amersham Eraser tray open

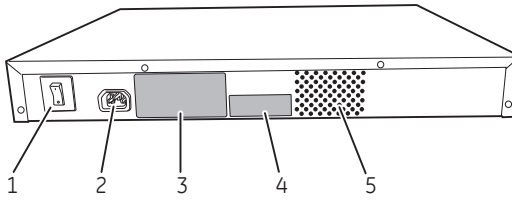

### 3 Product description

#### Amersham Eraser rear view



















Part	Function
1	Power switch  <u>Toggle switch:</u>  1: Power ON   2: Power OFF
2	Power cable connector
3	System label
4	Label
5	Vent holes

## Amersham Eraser panel

Start and set eraser time on the panel of Amersham Eraser.





The table below shows the symbols on the display and their meaning.

Symbol	Indicator/Button	Description												
	White	Standby (power on).												
	Blue	Run (erasing).  <div style="text-align: right;"><u>Total run time</u></div> <table style="margin-left: auto; margin-right: auto;"> <tr> <td>One</td> <td></td> <td>10 min</td> </tr> <tr> <td>Two</td> <td></td> <td>20 min</td> </tr> <tr> <td>Three</td> <td></td> <td>40 min</td> </tr> <tr> <td>Four</td> <td></td> <td>60 min</td> </tr> </table>	One		10 min	Two		20 min	Three		40 min	Four		60 min
One		10 min												
Two		20 min												
Three		40 min												
Four		60 min												
	Red	Error.												
	White	<b>RUN</b> button. Used to set erasure time and <b>RUN</b> . Can also be used to change erasing time during run or to turn the Amersham Eraser into standby mode.												

### 3 Product description

#### Accessories

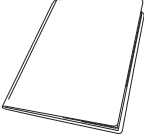
The following items are included with the delivery of Amersham Eraser.

Part	Description
	Amersham Eraser Operating Instructions
	AC power cord for North America
	AC power cord for Europe

# 4 Installation

## About this chapter

This chapter provides information regarding installation of Amersham Eraser.

## Precautions



### CAUTION

Make sure that the instrument has reached room temperature before starting the power supply, if previously placed in a cold room.



### CAUTION

Install the Amersham Eraser in a location where it will not come into contact with water or chemicals.



### CAUTION

When moving the instrument do not hold the tray, it may open and cause injury.

## 4.1 Site requirements

Parameter	Requirement
Free space required around Amersham Eraser	Front of the instrument (the operation panel side): 700 mm
	Right: 0 mm
	Left: 0 mm
	Rear: 100 mm
	Top: 100 mm

## 4 Installation

### 4.1 Site requirements

Parameter	Requirement
Power requirements	Line voltage: 100-240 V AC $\pm$ 10%
	Power: 100 W
	Frequency: 50/60 Hz
Ambient temperature	18°C to 28°C (with temperature fluctuation below 10°C per hour or lower)
Placement	Stable laboratory bench
Humidity	20% to 70% RH (no dew condensation)

### 4.2 Transport

The Amersham Eraser weighs approximately 10 kg.

Follow the instructions before moving the instrument:

- 1 Turn off the instrument.
- 2 Disconnect the power cord.

### 4.3 Unpacking

Check the equipment for any apparent damage before installing.

If the Amersham Eraser is damaged, document any damage carefully and contact your GE representative.

### 4.4 Connections

Connect the Amersham Eraser power cord to a grounded power outlet.

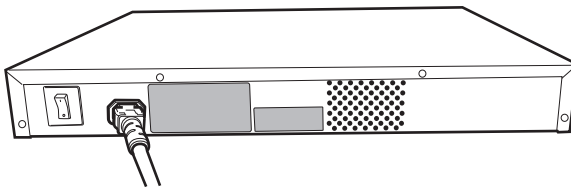



## 4.5 Placement



### CAUTION

Do not place the instrument on unstable tables or on inclined surfaces, as the equipment could be tipped over or fall, resulting in injury or damage to the instrument.



### CAUTION

Do not block the venting holes and make sure that the vents are kept free of dust and dirt. Blockage of the vents can result in overheating of the equipment and malfunction.

Four rubber feet are attached to the bottom surface. Set the Amersham Eraser so that all four rubber feet are on the stable laboratory bench.

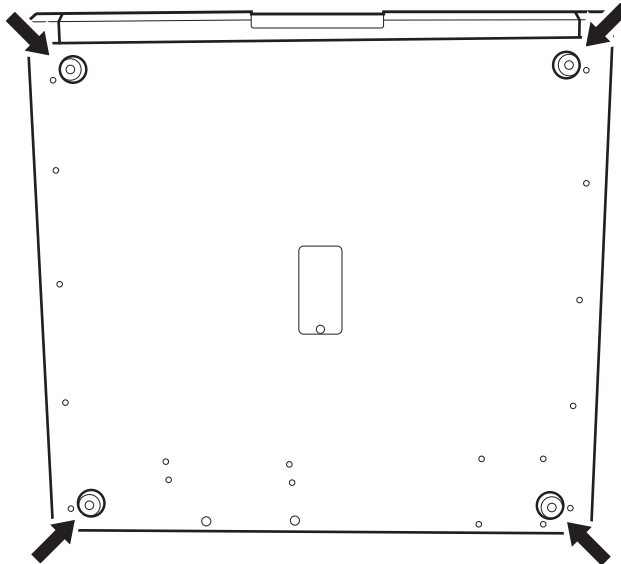

# 5 Operation

## About this chapter

This chapter provide instructions for how to erase a storage phosphor screen and erasure time guidelines.

---

## Precautions



### WARNING

If liquid is spilled on the instrument, the electrical power supply must be disconnected immediately. The instrument must be completely dry on the inside and the outside before reconnecting the power supply.



### WARNING

If a metallic object, water, fluid or foreign matter penetrates the instrument, turn off the instrument, disconnect the AC power cable, and contact the GE representative. Failure to disconnect the power under these circumstances may cause fire or electric shock.



### WARNING

Do not use the instrument if smoke, strange noises or strange odors can be perceived, or if the instrument becomes unusually hot. This can result in fire or electric shock. Stop using the equipment immediately, turn off the power switch and unplug the equipment from the power outlet. Contact your GE representative to request repair.



### CAUTION

Do not place heavy objects on the instrument, these may fall off and cause injury.

**CAUTION**

Do not press your hand or place heavy objects on the instrument. The surface may break and cause personal injury.

**CAUTION**

Do not insert hands into the Amersham Eraser while the tray is open.

**CAUTION**

When lifting and moving the instrument be careful not to drop it. This may cause injury.

**CAUTION**

Do not look directly at an Amersham Eraser light source, it may cause injury to the eyes.

**CAUTION**

When opening or closing the tray, make sure that no objects or body parts are caught in the tray when closing.

**CAUTION**

Do not lean on the tray, it might cause breakage to the instrument, or the instrument may tip over and cause injury.

## 5 Operation

### 5.1 Erase a storage phosphor screen

## 5.1 Erase a storage phosphor screen

### Start Amersham Eraser

- | Step | Action                    |
|------|---------------------------|
| 1    | Turn on the power switch. |

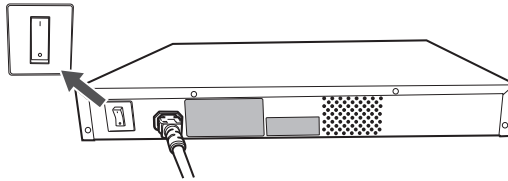

- |   |  |
|---|--|
| 2 | The indicator lights up and Amersham Eraser enters standby mode. |
|---|--|

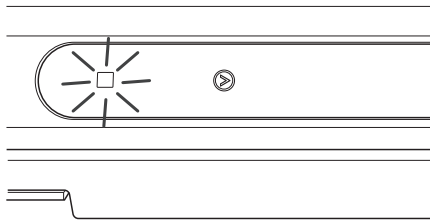

### Erase a storage phosphor screen

Follow the procedure below to erase a storage phosphor screen.

- | Step | Action  |
|------|---|
| 1    | Insert your fingers in the slot under the instrument. |

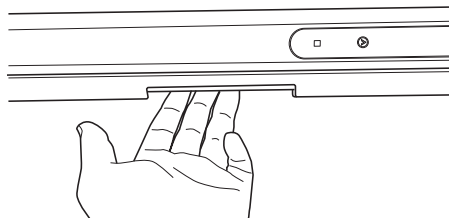

Step	Action
------	--------

2	Pull out the tray.
---	--------------------

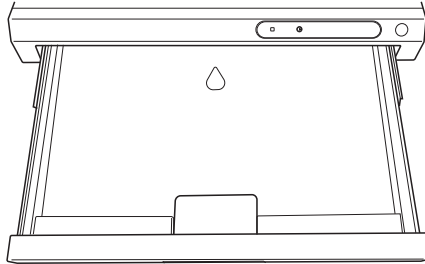

3	Fit the phosphor screen onto the tray.
---	--

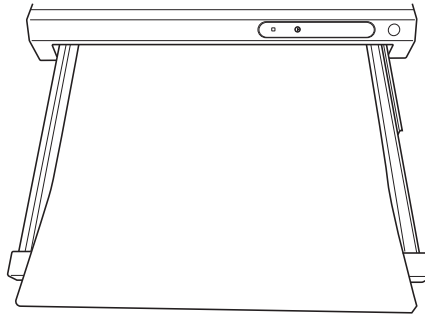

4	Check that the exposure surface faces up on the phosphor screen.
---	--

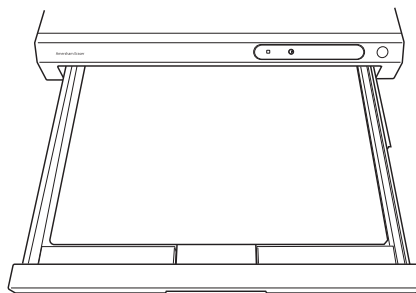

5	Push the tray back to its original position.
---	--

## 5 Operation

### 5.1 Erase a storage phosphor screen

Step	Action
------	--------

6



Press the **(RUN)** button to set erasure time and start erasing. See [Amersham Eraser panel, on page 21](#).

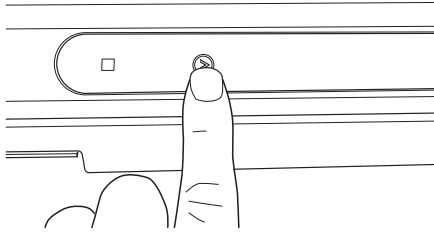

*Result:* The erasing starts.

## Erasing is finished

As erasing time elapses, the blue indicators will turn off one by one from right to left. If the tray is withdrawn during erasing, erasing will be canceled at that point.

Step	Action
------	--------

- |   |                    |
|---|--------------------|
| 1 | Pull out the tray. |
|---|--------------------|

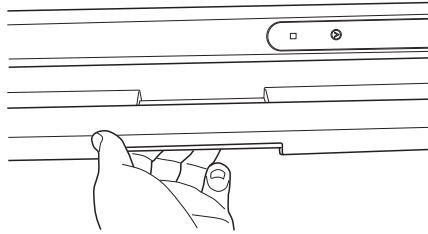

- |   |   |
|---|---|
| 2 | Remove the phosphor screen by inserting your hand into the front opening in the middle, as shown below. |
|---|---|

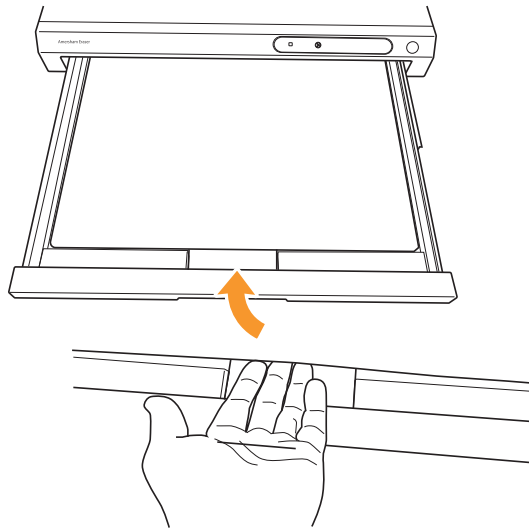

## 5 Operation

### 5.1 Erase a storage phosphor screen

Step	Action
------	--------

3	The tray is empty.
---	--------------------

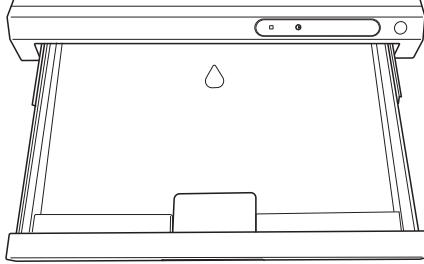

4	Return the tray to its original position.
---	---

## 5.2 Erasure time guidelines

### Erasure time

The following table gives a guide of erasure times based on how the storage phosphor screen was previously exposed.

Condition	Erasure time
Normal	10 minutes or more
Over-exposed	40 minutes or more
Unknown	40 minutes or more

**Tip:** Perform a trial reading of the storage phosphor screen if you are not sure that the storage phosphor screen is fully erased.

Erase the storage phosphor screen just before exposure. Even though the storage phosphor screen was once erased completely, after the elapse of a certain period of time, the background noise will increase.



# 6 Maintenance

## About this chapter

This chapter provides instructions for routine maintenance of the Amersham Eraser.

---

## Precautions



### WARNING

**Disconnect power.** Always disconnect power from the instrument before performing any maintenance task.



### WARNING

Disconnect the power cord before cleaning the instrument.



### WARNING

Use only a slightly damp cloth to clean the instrument. Excess dampness may cause fire or electric shock. Never use a damp cloth to clean the inside of the Amersham Eraser.



### WARNING

Do not place any vessels containing water or metallic objects on the instrument. If liquid or metallic objects penetrate the instrument, fire and electric shock may result.

## Cleaning the Amersham Eraser

Clean using a soft cloth dipped in water and then wrung dry.

To remove heavier contamination, a neutral detergent diluted with water may be used. Wipe afterwards with a dry soft cloth to remove any remaining detergent.

---

# 7 Troubleshooting

## About this chapter

This chapter describes possible causes and corrective actions for various problems with the instrument.

---

## Troubleshooting guide

Problem	Action
Noise comes from Amersham Eraser.	Turn off the power switch immediately and unplug the equipment from the power outlet. Contact your GE representative.
Atypical odors are emitted from the Amersham Eraser.	Turn off the power switch immediately and unplug the equipment from the power outlet. Contact your GE representative.
Smoke is emitted from Amersham Eraser.	Turn off the power switch immediately and unplug the equipment from the power outlet. Contact your GE representative.
The red indicator is lit.	Turn off the power switch immediately and unplug the equipment from the power outlet. Contact your GE representative.
The Amersham Eraser does not power up even after the power cable is connected correctly.	Turn off the power switch immediately and unplug the equipment from the power outlet. Contact your GE representative.

# 8 Reference information

## About this chapter

This chapter contains technical data, regulatory and other information.

---

## General specifications

Parameter	Value
Instrument name	Amersham Eraser
Dimensions (h x w x d) (mm)	78 x 550 x 510
Weight	10 kg
Placement	A stable laboratory bench with a load capacity of 588 N (60 kg) or higher Levelness tolerance: 2 degrees

## Technical specifications

Parameter	Value	
Power requirements	Line voltage:	100-240 V AC $\pm$ 10%
	Power:	100 W
	Frequency:	50/60 Hz
Transient overvoltages	Overvoltage category II	

## Environmental limits

Parameter	Value
Ambient temperature	18°C to 28°C
Relative humidity tolerance	20% to 70%RH no dew condensation
Altitude	Not above 2000 m
Site requirement	Indoor use only
Ingression protection	IP 21
Acoustic noise level	< 60 dB A
Pollution degree	2
Transportation/storage conditions	Temperature: -20°C to 70°C Humidity: 5% to 95% RH (no dew condensation)

# Index

## A

Amersham Eraser  
 cleaning, 33  
 connections, 24  
 environmental specifications, 36  
 general specifications, 35  
 intended use, 3  
 panel, 21  
 placement, 25  
 rear view, 20  
 technical specifications, 35  
 transport, 24  
 tray, 19  
 unpacking, 24

## C

CE  
 conformity, 5  
 CE marking, 6  
 Cleaning, 33

## E

Emergency shutdown, 15  
 Environmental specifications, 36  
 Erasing  
 run, 28  
 start, 28  
 stopped, 31  
 time guidelines, 32  
 Error indicator, 21

## F

FCC compliance, 7

## G

General specifications, 35

## I

Indicator panel, 21

International standards, 6

## L

Labels  
 FCC and ICES label, 14  
 placement, 12  
 system label, 13

## M

Maintenance, 33  
 Manufacturing information, 5

## N

Notes and tips, 4

## P

Power cord, 22  
 Purpose of this manual, 3

## R

Recycling information  
 decontamination, 15  
 disposal of electrical components, 16  
 Regulatory information, 5

## S

Safety notices, 4  
 Safety precautions, 8  
 Site requirements, 23

## T

Technical specifications, 35  
 Transport, 24  
 Troubleshooting, 34

## U

UL conformity, 14  
 Unpacking, 24  
 User information  
 important, 3

For local office contact information, visit  
[www.gelifesciences.com/contact](http://www.gelifesciences.com/contact)

GE Healthcare UK Limited  
Amersham Place  
Little Chalfont  
Buckinghamshire, HP7 9NA  
United Kingdom

[www.gelifesciences.com/quantitative\\_imaging](http://www.gelifesciences.com/quantitative_imaging)

GE, GE monogram and Amersham are trademarks of General Electric Company.

© 2016 General Electric Company.  
First published Jun. 2016.

All goods and services are sold subject to the terms and conditions of sale of the company within GE Healthcare which supplies them. A copy of these terms and conditions is available on request. Contact your local GE Healthcare representative for the most current information.

GE Healthcare Bio-Sciences AB  
Björkgatan 30, 751 84 Uppsala, Sweden

GE Healthcare Europe GmbH  
Munzinger Strasse 5, D-79111 Freiburg, Germany

GE Healthcare Bio-Sciences Corp.  
100 Results Way, Marlborough, MA 01752, USA

GE Healthcare Dharmacon, Inc.  
2650 Crescent Dr., Lafayette, CO 80026, USA

HyClone Laboratories, Inc.  
925 W 1800 S, Logan, UT 84321, USA

GE Healthcare Japan Corporation  
Sanken Bldg. 3-25-1, Hyakunincho Shinjuku-ku, Tokyo 169-0073, Japan

